

GE Sensing

Features

- High reliability, solid state silicon pressure sensors
 - Available in differential version
 - Standard pressure ranges: 10 in H₂O (2.5 kPa), 1 psi (7 kPa)
 - Nonlinearity < 0.25% FSO
 - 5X overpressure limit
-

Applications

- Process control systems
 - HVAC
 - Respirators
 - Cabin pressure
-

P1302

NovaSensor Low Pressure Silicon Pressure Sensor Die

P1302 is a NovaSensor product.
NovaSensor has joined other GE
high-technology sensing
businesses under a new name—
GE Industrial, Sensing.

P1302 Specifications

Description

The P1302 piezoresistive pressure sensors are offered in a miniature 0.11 in x 0.13 in (2.7 mm x 3.2 mm) die. When excited with 1.5 mA, the P1302 produces a millivolt output that is proportional to input pressure. The P1302 is available as a differential and gage sensor. With NovaSensor's SenStable[®] process, the P1302 will provide very good long-term stability and excellent repeatability.

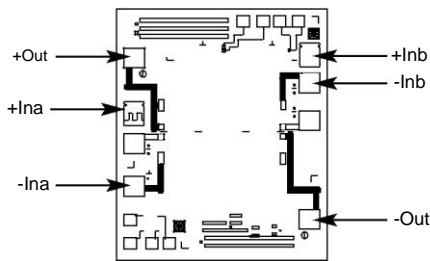

Die dimensions: 0.11 in x 0.13 in x 0.02 in (2.7 mm x 3.2 mm x 0.4 mm)

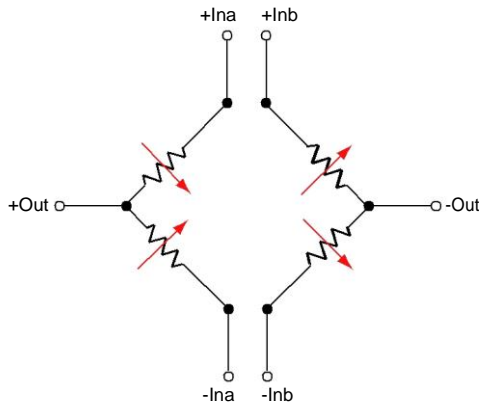

P1302 schematic diagrams

Parameter	Value	Units	Notes
General			
Pressure Range	10	in H ₂ O	2.5 kPa
	1	psi	7 kPa
Electrical @ 77°F (25°C) unless noted			
Excitation	1.5	mA	10 VDC Maximum
Input Impedance	5000±20%	Ω	
Output Impedance	5000±20%	Ω	
Environmental			
Temperature Range			
Operating	-40 to 257	°F	(-40°C to +125°C)
Storage (undiced)	-67 to 302	°F	(-55°C to +150°C)
Mechanical			
Weight	0.00008	lb	(0.04 g)
Media Compatibility	Clean dry air, non-corrosive gases		
Performance Parameters (1)			
	Value (6)	Units	Notes
Zero Offset	± 75	mV	1
Full Scale Output (FSO)	40 to 120	mv	2.5 kPa
Full Scale Output (FSO)	75 to 200	mv	7 kPa
Linearity (7 kPa)	±0.25	%FSO	
Linearity (2.5 kPa)	±0.5	%FSO	
Pressure Hysteresis	0.2	%FSO	
Temperature Coefficient of Zero	30	:V/V/°C	3
Temperature Coefficient of Resistance	0.29	% /°C	3
Temperature Coefficient of Sensitivity	-0.2	%FSO/°C	3
Thermal Hysteresis of Zero	0.5	%FSO	3, 7 kPa
Thermal Hysteresis of Zero	0.75	%FSO	2.5 kPa
Position Sensitivity	0.1	%FSO/g	

1. 0 KPaA for absolute sensors, 0 KPaG for differential or gage sensors.
2. Best fit straight line.
3. Between 32°F and 158°F (0°C and 70°C).
4. Typical value over one year.
5. All values measured at 77°F (25°C) and 1 mA excitation, unless otherwise noted.

Shipping and Handling

All wafers are shipped in protective containers. The wafers are sawn on sticky tape with rings. All wafers are electrically probed and visually inspected. Samples from each wafer verify offset, FS output, and linearity. Electrical rejects are inked with red dots. Visual rejects are inked with black or blue dots. Each wafer will have the following information: Lot number, wafer number, device number, and the number of good dice.

Warranty

GE warrants its products against defects in material and workmanship for 12 months from the date of shipment. Products not subjected to misuse will be repaired or replaced. GE reserves the right to make changes without further notice to any products herein. GE Sensing makes no warranty, representation or guarantee regarding the suitability of its products for any particular application. GE does not assume any liability arising out of the application or use of any product or circuit and specifically disclaims, and all liability, without limitation consequential or incidental damages. The foregoing warranties are exclusive and in lieu of all other warranties, whether written, oral, implied or statutory. No implied statutory warranty of merchantability or fitness for a particular purpose shall apply.

GE
Sensing

P1302

Specifications

Ordering Information

Part Number	Description
51317	10 in H ₂ O (2.5 kPa D/G)
51318	1 psi (7 kPa D/G)

*Minimum Release Quantity: 2 wafers or
approximately 900 die*

GE Sensing

Features

- Highly reliable, solid state silicon pressure sensors
 - Available in absolute and differential versions
 - Standard pressure ranges: 0 to 100, 0 to 200, and 0 to 700 kPa
 - Nonlinearity < 0.25 %FSO
 - 2X overpressure limit
-

Applications

- Process control systems
 - Pneumatic controls
 - Biomedical instruments
 - Hydraulic systems
-

P111

Medium Silicon Pressure Sensor Die

P111 is a NovaSensor product. NovaSensor has joined other GE high-technology sensing businesses under a new name—GE Industrial, Sensing.

P111 Specifications

Description

GE's P111 piezoresistive pressure sensors are offered in a miniature 0.10 in x 0.12 in (2.7 mm x 3.2 mm) die. When excited with 1.0 mA, the P111 produces a millivolt output that is proportional to input pressure. The P111 is available as an absolute pressure sensor where the media pressure is referenced to an internal vacuum sealed in the die. The P111 is also available as a differential and gage sensor. With NovaSensor's SenStable[®] process, the P111 will provide very good long-term stability and excellent repeatability. Sensor die have a 63 mil glass constraint layer. For thicker isolation constraint contact the factory.

Parameter	Value	Units	Notes
General			
Pressure Range	100	KPa	-15 psi (-1 bar)
	200	KPa	-30 psi (-2 bar)
	700	KPa	-100 psi (-7 bar)
Maximum Overpressure	2X		rated pressure
Electrical @ 72°F (25°C) unless noted			
Excitation	1.0	mA	10 VDC Maximum
Input Impedance	5000 ±20%	Ω	
Output Impedance	5000 ±20%	Ω	
Environmental			
Temperature Range			
Operating	-40 to 257	°F	(-40°C to 125°C)
Storage	-67 to 302	°F	(-55°C to 150°C)
Mechanical			
Weight	0.00009	lb	(0.04 grams)
Media Compatibility	Clean dry air, non-corrosive gases		
Performance Parameters (1)			
	Value (6)	Units	Notes
Zero Offset	±50	mV	1
Full Scale (FS) Output	133 ± 33	mV	
Linearity	0.25	%FSO	2
Pressure Hysteresis	0.05	%FSO	
Temperature Coefficient of Zero	30	:V/V / °C	3
Temperature Coefficient of Resistance	0.27	% / °C	3
Temperature Coefficient of Sensitivity	-0.19	%FSO/°C	3
Thermal Hysteresis of Zero	0.2	%FSO	3
Long Term Stability of FSO	0.2	%FSO	4

1. 0 KPaA for absolute sensors, 0 KPaG for differential or gage sensors.
 2. Best fit straight line.
 3. Between 32°F and 158°F (0°C and 70°C).
 4. Typical value over one year.
 5. All values measured at 77°F (25°C) and 1 mA excitation, unless otherwise noted.

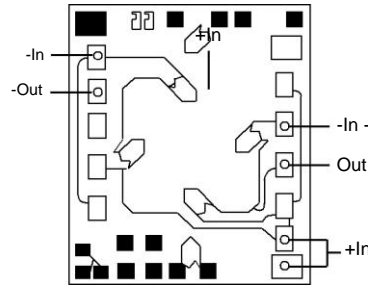
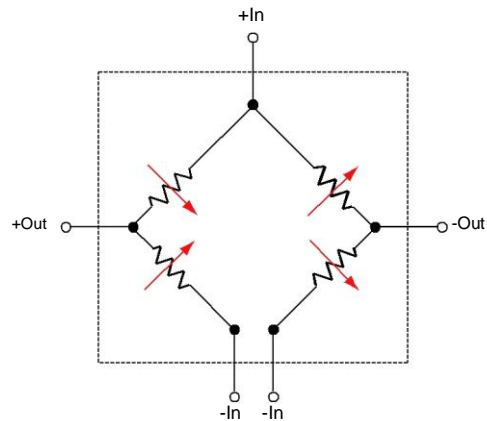

Die dimensions: 0.10 in x 0.12 in x 0.07 in (2.7 mm x 3.2 mm x 2 mm)

P111 schematic diagrams

Shipping and Handling

All wafers are shipped in protective containers. The wafers are sawn on sticky tape with plastic rings. All wafers are electrically probed and visually inspected. Samples from each wafer verify offset, FS output, and linearity. Electrical rejects are inked with red dots. Visual rejects are inked with blue dots. Each wafer will have the following information: Lot number, wafer number, device number, and the number of good dice.

Warranty

GE warrants its products against defects in material and workmanship for 12 months from the date of shipment. Products not subjected to misuse will be repaired or replaced. GE reserves the right to make changes without further notice to any products herein. GE makes no warranty, representation or guarantee regarding the suitability of its products for any particular application. GE does not assume any liability arising out of the application or use of any product or circuit and specifically disclaims, and all liability, without limitation consequential or incidental damages. The foregoing warranties are exclusive and in lieu of all other warranties, whether written, oral, implied or statutory. No implied statutory warranty of merchantability or fitness for a particular purpose shall apply.

GE
Sensing

P111

Specifications

Ordering Information

Part Number	Description
51006	100 KPaD/G
51007	200 KPaD/G
51008	700 KPaD/G
51010	100 KPaA
51011	200 KPaA
51012	700 KPaA

*Minimum Release Quantity: 2 wafers or
approximately 900 die*

GE

Sensing & Inspection Technologies

P112 Medium Pressure Sensor Die

Silicon Pressure Sensor Die

Features

- High reliability, solid state silicon pressure sensors
- Available in absolute, differential and gauge versions
- Standard pressure ranges: 15, 30, 50, 100, 200, 300, and 500 psi (1.03, 2.06, 3.44, 6.89, 13.78, 20.68, and 34.47)
- Nonlinearity <0.25 % FSO
- Can be temperature compensated to run off a voltage or current supply.
- 2X overpressure limit

Applications

- Process control systems
- Pneumatic controls
- Biomedical controls
- Hydraulic systems

Description

The NovaSensor P112 piezoresistive pressure sensor is offered in a miniature 2.7mm x 3.2 mm (0.10 in x 0.12 in) die. When excited with 1.0 mA, the P112 produces a millivolt output that is proportional to input pressure. The P112 is available as an absolute pressure sensor where the media pressure is referenced to an internal vacuum sealed in the die. The P112 is also available as a differential and gauge sensor. With NovaSensor's SenStable[®] process, the P112 will provide very good long-term stability and excellent repeatability. With NovaSensor's "flat process," the P112 can be temperature compensated for either a constant current or a constant voltage power supply.

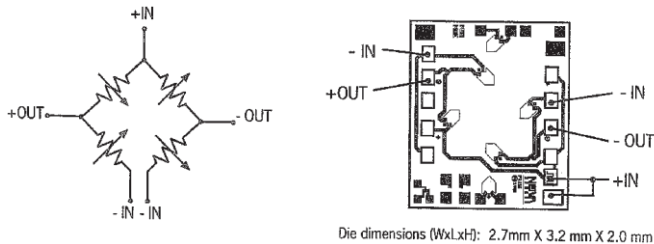

Schematic and wirebond diagram

P112 Medium Pressure Sensor Die Specifications

Parameter	Value	Units	Notes
General			
Pressure Ranges	15	psi	≈103 kPa
	30	psi	≈207 kPa
	50	psi	≈345 kPa
	100	psi	≈689 kPa
	200	psi	≈1379 kPa
Maximum Overpressure	2X	rated pressure	
Electrical @ 25°C (72°F) unless otherwise stated			
Excitation	1.0	mA	10 VDC Max
Input Impedance	5000 ±20%	W	
Output Impedance	5000 ±20%	W	
Environmental			
Temperature Range			
Operating	-40 to 125	°C	40°F to 257°F
Storage	-55 to 150	°C	-67°F to 302°F (Note 6)
Mechanical			
Weight	0.04	grams	
Media Compatibility	Clean, dry air noncorrosive gases		
Performance Parameters (Note 5)			
	Units	Value (5)	Notes
Zero Offset	mV	±25	1
Full Scale Output	mV	85 to 127	
Linearity	%FSO	±.25	2
Pressure Hysteresis	%FSO	0.05	
Temperature	mV/V/°C	30	3
Coefficient of Zero			
Temperature	%/°C	0.38	3
Coefficient of Resistance			
Temperature	%FSO/°C	-0.19	3
Coefficient if Sensitivity			
Thermal	%FSO	0.2	3
Hysteresis of Zero			
Long Term Stability of FSO	% FSO	0.2	4

Notes:

- 0 kPaA for absolute sensors, 0 KPaG for differential or gauge sensors
- Best fit straight line
- Typical value between 0°C and 70°C (32°F and 158°F)
- Typical value over one year
- All values measured at 25°C (77°F) and 1 mA excitation, unless otherwise noted
- Sensor die only. Does not include ring, tape or case.

Ordering Information

Pressure	Gauge	Absolute
15 psi	51155	51156
30 psi	51206	51247
50 psi	51157	51158
100 psi	51159	51160
200 psi	51212	51269

Minimum release quantity: 2 wafers or approximately 900 dice.

www.baystar-inc.com
info@baystar-inc.com

GE Sensing

Features

- High reliability, solid state silicon pressure sensors
 - Available in absolute pressure version
 - Standard pressure ranges: 0 to 1700, 0 to 3500, 0 to 17000 and 0 to 350000 kPa
 - Nonlinearity < 0.25% FSO
 - 2X overpressure limit
-

Applications

- Process control systems
 - Pneumatic controls
 - Biomedical instruments
 - Hydraulic systems
-

P122

NovaSensor High Silicon Pressure Sensor Die

P122 is a NovaSensor product. NovaSensor has joined other GE high-technology sensing businesses under a new name—GE Industrial, Sensing.

P122 Specifications

Description

The P122 piezoresistive pressure sensors are offered in a miniature 0.10 in x 0.10 in (2.5 mm x 2.5 mm) die. When excited with 1.0 mA, the P122 produces a millivolt output that is proportional to input pressure. The P122 is available as an absolute pressure sensor where the media pressure is referenced to an internal vacuum sealed in the die. With GE's SenStable[®] process, the P122 will provide very good long-term stability and excellent repeatability.

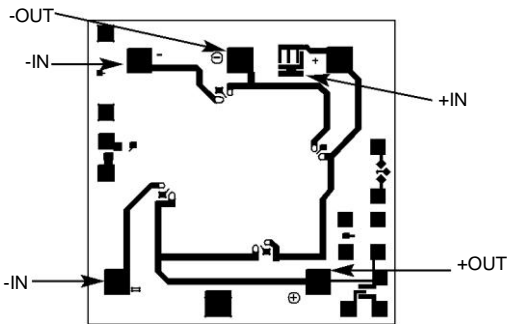

Die dimensions: 0.10 in x 0.10 in x 0.07 in (2.5 mm x 2.5 mm x 1.8 mm)

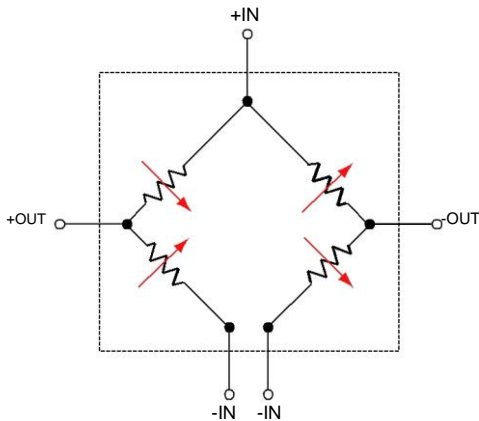

P122 schematic diagrams

Parameter	Value	Units	Notes
General			
Pressure Range	1700	KPaG	≈250 psi (-1.03 bar)
	3500	KPaA	≈500 psi (-2.06 bar)
	7000	KPaA	≈1000 psi (-6.89 bar)
	35000	KPaA	≈5000 psi
Maximum Overpressure	2X		rated pressure

Electrical @ 25°C (77°F) unless otherwise stated			
Excitation	1.0	mA	10 VDC Maximum
Input Impedance	5000 ±20%	Ω	
Output Impedance	5000 ±20%	Ω	

Environmental			
Temperature Range			
Operating	-40 to 257	°F	(-40°C to 125°C)
Storage (undiced)	-67 to 302	°F	(-55°C to 150°C)

Mechanical			
Weight	0.00008	lb	(0.04 g)
Media Compatibility	Clean dry air, non-corrosive gases		

Performance Parameters (1)			
	Value (6)	Units	Notes
Zero Offset	±50	mV	1
Full Scale Output (FSO)	240 ±35	mV	6
Linearity	±0.25	%FSO	2
Pressure Hysteresis	±0.05	%FSO	
Temperature Coefficient of Zero	±30	:V/V/°C	3
	0.27	% /°C	3
Temperature Coefficient of Resistance	-0.19	%FSO/°C	3
Thermal Hysteresis of Zero	0.2	%FSO	3
Long Term Stability of FSO	0.2	%FSO	4

- 1.0 KPaA for absolute sensors, 0 KPaG for differential or gage sensors.
2. Best fit straight line.
3. Between 32°F and 158°F (0°C and 70°C).
4. Typical value over one year.
5. All values measured at 77°F (25°C) and 1 mA excitation, unless otherwise noted.
6. 133 ± 33 mV for 51009 and 51013

Warranty

GE warrants its products against defects in material and workmanship for 12 months from the date of shipment. Products not subjected to misuse will be repaired or replaced. GE reserves the right to make changes without further notice to any products herein. GE Sensing makes no warranty, representation or guarantee regarding the suitability of its products for any particular application. GE does not assume any liability arising out of the application or use of any product or circuit and specifically disclaims, and all liability, without limitation consequential or incidental damages. The foregoing warranties are exclusive and in lieu of all other warranties, whether written, oral, implied or statutory. No implied statutory warranty of merchantability or fitness for a particular purpose shall apply.

GE
Sensing

P122

Specifications

Ordering Information

Part Number	Description
51009	1700 KPaG
51013	1700 KPaA
51003	7000 KPaA
51004	17200 KPaA
51005	35000 KPaA

*Minimum Release Quantity: 2 wafers or
approximately 1100 die*

GE Sensing

Features

- Very small size
 - Standard pressure range –50 to 300 mmHg
 - AC or DC excitation
 - 4000 mmHg burst limit
-

Applications

- IUP
 - Intracranial
 - Disposable catheter
-

P161

NovaSensor 3F Medical Silicon Pressure Sensor Die

P161 is a NovaSensor product.
NovaSensor has joined other
GE high-technology sensing
businesses under a new
name— GE Industrial, Sensing.

P161 Specifications

Description

GE's NPD-240 piezoresistive pressure sensor die are offered in a miniature 1150 x 725 :m die that is small enough for three French catheters. The small die size is made possible by GE Sensing's proprietary silicon fusion bonding (SFB) process. When excited with an AC or DC voltage source, the NPD-240 produces a mV output that is proportional to input pressure. The NPD-240 is in a half-bridge design, where external resistors are needed to complete a full bridge configuration.

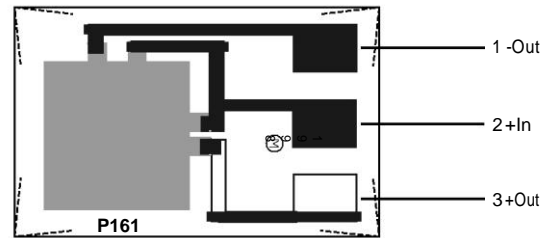
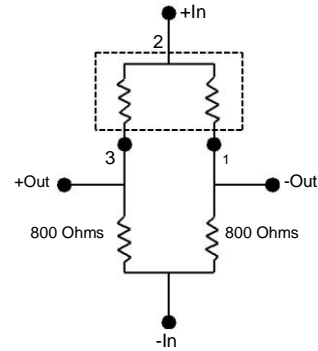

Die dimensions (l x w x h): 1150 μ m x 725 μ m x 170 μ m

P161 schematic diagrams

Performance Parameters ⁽¹⁾			
	Value ⁽²⁾	Units	Notes
Pressure Range	-50 to 300	mmHg	
Operating Temperature	50 to 122	°F	(10°C to 50°C)
Excitation	1 to 8	Volts	AC or DC
Zero Offset	±12.5	mV/V	
Sensitivity	12 to 24	:V/V/mmHg	2
Linearity and Pressure Hysteresis	±2% of reading or ±1 mmHg whichever is larger	%FSO	3, 4
Temperature Coefficient of Zero	±40	μ V/V / °C	Typical
Temperature Coefficient of Resistance	0.15	% / °C	Typical
Temperature Coefficient of Sensitivity	-0.2	%FSO/°C	Typical
Bridge Resistance	800 ± 20%	Ω	
Symmetry	5%		5
Burst Pressure	4000	mmHg	
Media Compatibility	Clean, dry, and non-corrosive gases		6

1 Values measured at 0.6 mA and 71.6°F (22 °C) unless noted with 800 Ω resistor between +Out and -IN, and -Out and -IN. Die performance will vary depending on die attach material. The die attach material should be chosen to minimize package stress transmitted to the sensor die.

2 Sensitivity at 100 mmHg.

3 Error at 300 mmHg from straight line through the zero pressure and 100 mmHg readings

4 Topside pressure.

5 Percent of the bridge resistor with the lowest value. Symmetry is the difference between the two bridge resistor values.

6 A protective coating must cover the sensor die for use with saline and other fluids.

Part Number

©2006 GE. All rights reserved. 920-257A

All specifications are subject to change for product improvement without notice. GE[®] is a registered trademark of General Electric Co. Other company or product names mentioned in this document may be trademarks or registered trademarks of their respective companies, which are not affiliated with GE.

Shipping And Handling

Wafers are shipped in protective plastic containers. The wafers are sawn on sticky tape with rings. All sensor wafers are electrically probed, visually inspected. All rejects are marked by an ink dot. Each wafer will be labeled with the lot number wafer number, device number and the number of available sensor die.

Warranty

GE warrants its products against defects in material and workmanship for 12 months from the date of shipment. Products not subjected to misuse will be repaired or replaced. GE reserves the right to make changes without further notice to any products herein. GE makes no warranty, representation or guarantee regarding the suitability of its products for any particular application. GE does not assume any liability arising out of the application or use of any product or circuit and specifically disclaims, and all liability, without limitation consequential or incidental damages. The foregoing warranties are exclusive and in lieu of all other warranties, whether written, oral, implied or statutory. No implied statutory warranty of merchantability or fitness for particular purpose shall apply.

Ordering Information

51186

Description
3F, 300 mmHg

www.baystar-inc.com
info@baystar-inc.com

GE Sensing

Features

- Highly reliable, silicon pressure sensor
 - Low-cost for disposable applications
 - 0 to 100 mmHg pressure range
 - Radiation tolerant design
 - Linearity errors less than 1% in physiological pressure range
-

Applications

- Disposable pressure transducer (DPT)
 - Intrauterine pressure (IUP)
 - Biomedical instruments
 - Infusion pumps
-

P562

NovaSensor Medical Silicon Pressure Die

P562 is a NovaSensor product.
NovaSensor has joined other
GE high-technology sensing
businesses under a new
name— GE Industrial, Sensing.

P562 Specifications

Description

GE's P562 piezoresistive pressure sensor is specifically designed for medical applications. Low linearity errors and low input and output impedance make the P562 an industry standard for disposable pressure sensor die. The sensor die is radiation tolerant for newer sterilization methods. Wire bonds are located on one side to minimize package width for DPT's and IUP's. Choose an open bridge wirebond configuration depending on your compensation circuit. Sensitivity can be easily scaled with external circuitry to meet the AAMI standard of 5 :V/V/mmHg sensitivity.

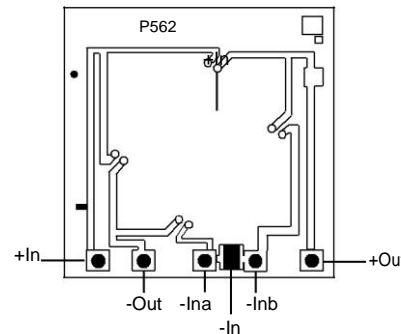
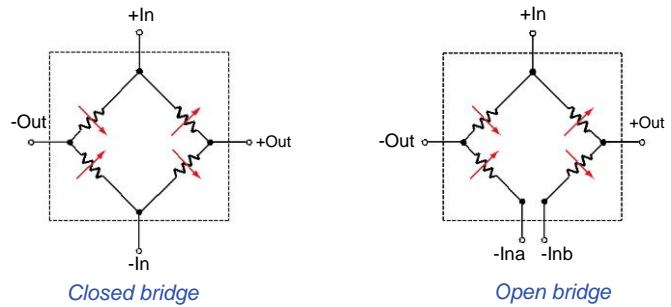

Die dimensions: 0.08 in x 0.08 in x 0.01 in (2.1 mm x 2.1 mm x 0.4 mm)

P562 schematic and wirebond diagram

Parameter	Value	Units	Notes
General			
Pressure Range	100	mmHg	-1.9 psi (-0.13 bar)
Maximum Overpressure	125	psi	Topside pressure (9 bar)
Electrical @ 72°F (25°C) unless noted			
Excitation	3.0	mA	3 VDC Maximum
Input Impedance	305 to 400	Ω	
Output Impedance	305 to 400	Ω	
Environmental			
Temperature Range			
Operating	32 to 158	°F	(0°C to 70°C)
Storage	-13 to 185	°F	(-25°C to 85°C)
Mechanical			
Weight	0.00004	lb	(0.02 grams)
Media Compatibility	Clean dry air, non-corrosive gases		
Performance Parameters (1)			
Zero Offset	±4	mV/V	2
Sensitivity	44 ±11	V/V/mmHg	
Linearity	1.5	%FSO	3
Pressure Hysteresis	0.1	%FSO	
Temperature Coefficient of Zero	30	V/V/°C	4
Temperature Coefficient of Resistance	0.16	%/°C	4
Temperature Coefficient of Sensitivity	-0.11	%FSO/°C	4
Thermal Hysteresis of Zero	0.1	%FSO	4
Long Term Stability of FSO	0.1	%FSO	5

1. All values measured at 72°F (25°C) and 1 mA excitation, unless otherwise noted. 2. Zero psig.
3. Measured as the deviation at 300 mmHg from a line drawn from the output at zero pressure through the output at 100 mmHg.
4. Between 32°F and 158°F (0°C and 70°C). 5. Typical value over one year.

Shipping and Handling

All wafers are shipped in protective containers. The wafers are sawn on sticky tape with plastic rings. All wafers are electrically probed and visually inspected. Samples from each wafer verify offset, full-scale output, and linearity. Electrical rejects are inked with red dots. Visual rejects are inked with blue dots. Each wafer will have the following information: Lot number, wafer number, device number, and the number of good dice.

Warranty

GE warrants its products against defects in material and workmanship for 12 months from the date of shipment. Products not subjected to misuse will be repaired or replaced. GE reserves the right to make changes without further notice to any products herein. GE makes no warranty, representation or guarantee regarding the suitability of its products for any particular application. GE does not assume any liability arising out of the application or use of any product or circuit and specifically disclaims, and all liability, without limitation consequential or incidental damages. The foregoing warranties are exclusive and in lieu of all other warranties, whether written, oral, implied or statutory. No implied statutory warranty of merchantability or fitness for a particular purpose shall apply.

GE
Sensing

P562

Specifications

Ordering Information

Part Number Description

51279 100 mmHg sensor

Minimum Release Quantity

Two wafers or approximately 2000 die

GE Sensing

Features

- Highly reliable, solid state
 - Available in absolute or gage (differential)
 - Available with varying glass thickness or no glass at all (consult GE for more information)
 - Designed to be temperature compensated using constant current or voltage
 - NovaSensor's proprietary SenStable[®] process produces excellent long-term stability
-

Applications

- Level sensing
 - Automotive systems
 - Process control
 - Pneumatic controls
 - Hydraulic systems
-

P883

NovaSensor Medium Silicon Pressure Sensor Die

P883 is a NovaSensor product. NovaSensor has joined other GE high-technology sensing businesses under a new name— GE Industrial, Sensing.

GE
Sensing
P883

Specifications

Description

The P883 utilizes four matched valued piezoresistors in a wheat stone bridge circuit. When excited (1.0 mA, DC), the P883 produces a differential millivolt output signal that is directly proportional to the pressure applied. Available as gage (differential) or absolute, the P883 is also designed for reduced temperature hysteresis over a wide temperature range. All die are visually inspected and are electrically probed to verify zero offset. Samples from each wafer are tested for sensitivity, linearity and temperature coefficients.

Parameter	Value	Units	Notes
General			
	5	psi	(0.34 bar)
	15	psi	(1 bar)
	30	psi	(2 bar)
	70	psi	(5 bar)
	150	psi	(10 bar)
	300	psi	(21 bar)
Maximum Pressure	3 x	rated pressure	
Environmental			
Electrostatic damage (ESD) Class 1			MIL-STD 883 method 3015
Temperature Range			
Operating	-40° to 257°	°F	(-40°C to 125°C)
Storage	-67° to 302°	°F	(-55°C to 150°C)
Mechanical ⁽¹⁾			
Weight	0.000009	lb	0.04 grams
Media Compatibility	Clean, dry air, and noncorrosive gases		
Electrical @ 72°F (25°C), 1.0mA, and note 6 unless otherwise stated			
Excitation	1.0	mA	10 VDC maximum
Input Impedance	5,000 ± 20%	Ω	
Output Impedance	5,000 ± 20%	Ω	
Zero Offset	±10	mV/V	1
Full Scale (FS) Output	133 ±33	mV	
Linearity	0.25	%FSO	2, 5
Zero Pressure			
Repeatability	0.1	%FSO	1
Thermal Coefficient of Zero			
	25	:V/V/°C	3
Thermal Coefficient of Resistance			
	0.38	%/°C	3
Thermal Coefficient of Sensitivity			
	-0.19	%FSO/°C	3
Zero Thermal Repeatability			
	0.50	%FSO	4

1. 0 kPaA for absolute sensors, 0 kPaG for differential or gage sensors.
 2. Best fit straight line. 3. Between 32°F and 158°F (0°C and 70°C) 4. Between -40°F and 257°F (-40°C and 125°C) 5. 5 psig (0.34 bar) linearity; 0.30 %FSO best fit straight line.

For more information, please contact:

info@baystar-inc.com
www.baystar-inc.com

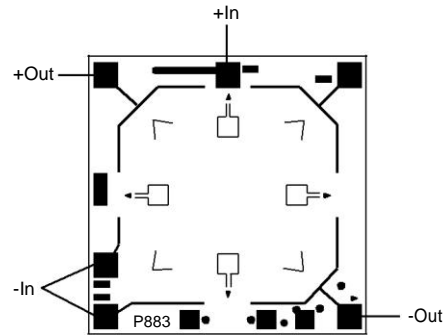
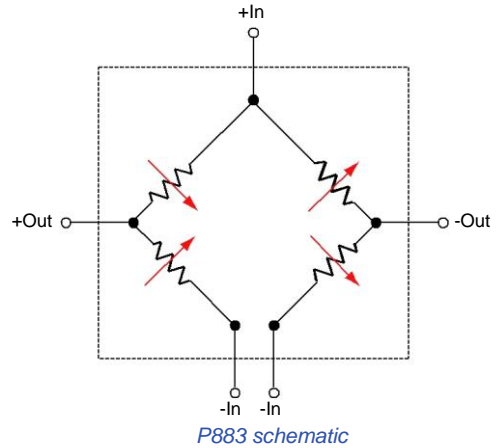

Die dimensions (w x l x h): 0.07 in x 0.07 in x 0.07 in (2 mm x 2 mm x 2 mm)

63 mil glass standard, 93 mil optional; 39 mil = 04. in (1 mm)

Shipping and Handling

All wafers are sawn on sticky tape with plastic rings and are shipped in protective plastic containers. Electrical rejects are inked with red dots, and visual rejects are inked with blue dots. Each wafer will have the following information: Lot number, wafer number, part number, and the number of good (yielded) die.

Warranty

GE warrants its products against defects in material and workmanship for 12 months from date of shipment. Products not subjected to misuse will be repaired or replaced. The foregoing is in lieu of any other expressed or implied warranties. GE reserves the right to make changes without further notice to any products herein. GE makes no warranty, representation or guarantee regarding the suitability of its products for any particular application. GE does not assume any liability, arising out of the application or use of any product or circuit, and specifically disclaims, and all liability, including without limitation consequential or incidental damage.